

SUYOJAN GROUP OF COMPANIES



TRUSTED HYDRAULIC SOURCE, UNMATCHED PERFORMANCE



| | |
|-------|------------------------------------------------------------------------------------------------------------------------------------------------------------------------------------------------------------------------------------------------------------------------------------------------------------------------------------------------------------------------------------------------------------------------------------------|
| 01 | <p>About us</p> <p>SUYOJAN Group of Companies is a leading provider of DANFOSS and various other International Brands in Hydraulics Sector, dedicated to delivering exceptional quality and service. With a commitment to sustainability and customer satisfaction, Our mission is to empower businesses through tailored solutions that drive growth and efficiency to meet the evolving needs of our clients.</p> |
| 2-5 | <p>DANFOSS</p> <p>Our Platinum Tier in MRO & Retail Market Partner Certification for DANFOSS</p> <ul style="list-style-type: none"> Hydraulic Motor Gear Motor Axial Piston Motor Gear Pump Vane Pump Axial Piston Pump Steering Unit Propotional Valves Cartridges Industrial Valves Cylinder JoyStick |
| 6-7 | <p>WHITE DRIVE</p> <ul style="list-style-type: none"> Orbital Motors |
| 8-9 | <p>BONDIOLI & PAVESI</p> <ul style="list-style-type: none"> Gear Pump Gear Motor Closed Circuit Axial Piston Pump Open Circuit Axial Piston Pump Roller Motor Axial Piston Motor Aluminium Heat Exchangers Rigid Coupling System Flexible Coupling System Radial Piston Motor Multiple Pump Drives: (BR, 8000) |
| 10-11 | <p>Bucher Hydraulics</p> <ul style="list-style-type: none"> Power Units Pumps Directional Valves Cartridges Valves |
| 12-13 | <p>VIVOIL</p> <ul style="list-style-type: none"> Unidirectional Pump Unidirectional Motor Reversible Motor Reversible Pump Flow Divider Special Flow Divider |
| 14-15 | <p>PMP HYDRAULICS</p> <ul style="list-style-type: none"> PMB (MIXER TRUCKGEAR BOX) PMH M/ MCF/ MKF (FIXED DISPLACEMENT MOTOR) PMH P (AXIAL PISTON PUMP) PMC (MIXER TRUCKGEAR BOX) |
| 16-17 | <p>Impro Fluidtek</p> <ul style="list-style-type: none"> Orbital Motors |
| 18-19 | <p>Advanced Testing Expert Repair Solutions</p> |
| 20 | <p>Power Pack Manufacturing</p> |
| 21 | <p>Applications</p> |

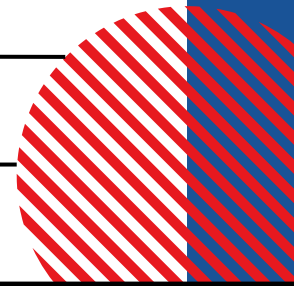

ABOUT US



Danfoss

We are Platinum Tier in MRO & Retail Market Partner for DANFOSS and Authorized Distributors to various other International brands.

We can provide Hydraulic motor / Axial Piston Pumps & Motors / Radial Piston Motors / Cartridge Valves / Steering Units / Gear boxes & various other products and solutions related to your hydraulics systems.

Company has vast experience and can offer service and solutions related to Mobile and Industrial Hydraulics.

We cater to various OEM's all over India .

Our Brands





Danfoss

ENGINEERING
TOMORROW

Danfoss

Certificate

2024

Suyojan Hydro Mechanical System

is a

P R E M I E R

PARTNER  **PROGRAM**

PLATINUM

MRO & Retail Market Partner



James Fitzgerald
Vice President of Global
Distribution Sales

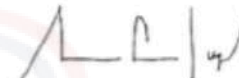

Mari Carmen Lugo
Vice President of Global
Channel Excellence

ENGINEERING
TOMORROW



Certificate

2024

Integrated Hydro Systems

is a

P R E M I E R

PARTNER



PROGRAM



PLATINUM

MRO & Retail Market Partner

James Fitzgerald
Vice President of Global
Distribution Sales

Mari Carmen Lugo
Vice President of Global
Channel Excellence

OUR PRODUCTS

● HYDRAULIC MOTOR



● GEAR MOTOR

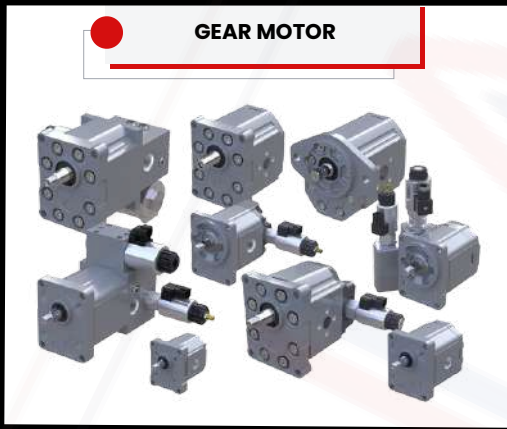

● AXIAL PISTON MOTOR



● GEAR PUMP



● VANE PUMP (VICKERS)



● AXIAL PISTON PUMP



● STEERING UNIT



● PROPOTIONAL VALVES

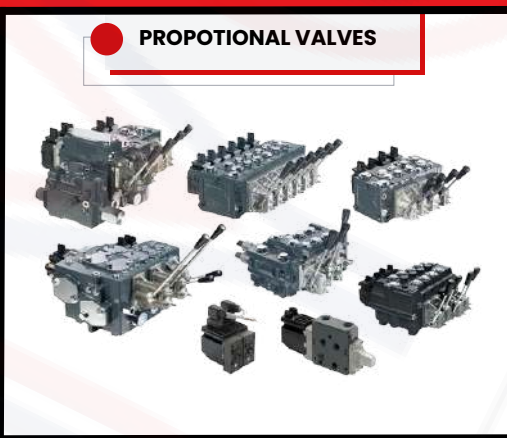

● CARTRIDGE



● INDUSTRIAL VALVES



● CYLINDERS



● JOYSTICK

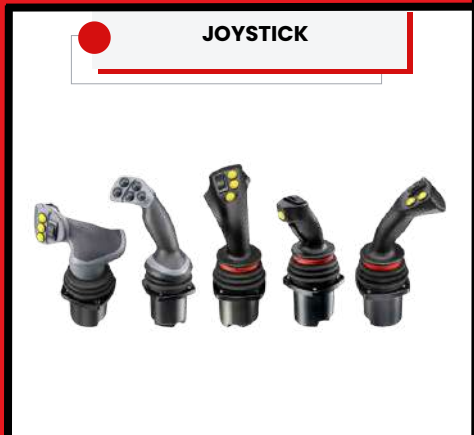



OUR PRODUCTS

**ORBITAL MOTOR
OMM**

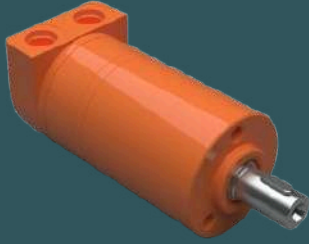

**ORBITAL MOTOR
OML**



**ORBITAL MOTOR
OMP**



**ORBITAL MOTOR
OMR**

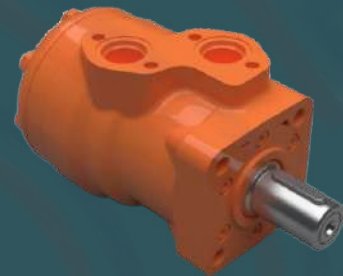

**ORBITAL MOTOR
OMS**



**ORBITAL MOTOR
OMH**



**ORBITAL MOTOR
D9**

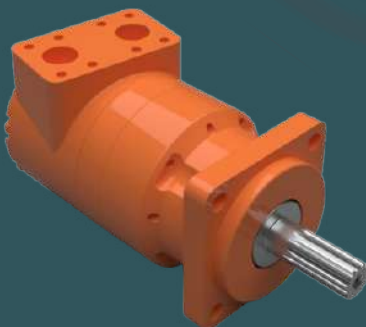

**ORBITAL MOTOR
RE SERIES**



**BONDIOLI
& PAVESI**



OUR PRODUCTS

GEAR PUMP



GEAR MOTOR



**CLOSE CIRCUIT
AXIAL PISTON PUMP**

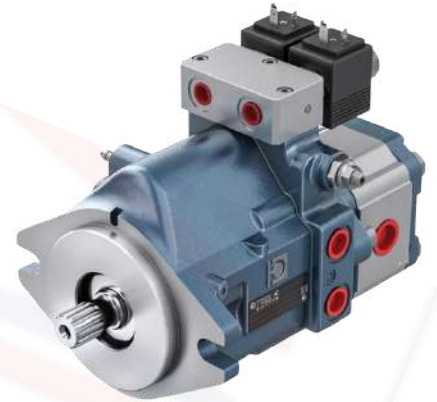

**OPEN CIRCUIT
AXIAL PISTON PUMP**



AXIAL PISTON MOTOR



RADIAL PISTON MOTOR



**ALUMINIUM HEAT
EXCHANGERS**



**MULTIPLE PUMP DRIVES
8000**



**MULTIPLE PUMP DRIVES
BR**



The logo features the word "BUCHER" in a bold, red, sans-serif font, positioned above the word "hydraulics" in a black, lowercase, sans-serif font. The text is centered on a white background. Surrounding the text are several large, abstract geometric shapes: a red triangle in the top-left, a black triangle in the bottom-left, and a red triangle in the middle-right. A faint, stylized hydraulic symbol is visible in the background, consisting of a circle with a vertical line through it and horizontal lines above and below, all in a light grey color.

BUCHER
hydraulics

OUR PRODUCTS

POWER UNITS



PUMPS



DIRECTIONAL VALVES



CARTRIDGES



VALVES





UNIDIRECTIONAL PUMP



OUR PRODDUCTS

UNIDIRECTIONAL MOTOR



REVERSIBLE PUMP



REVERSIBLE MOTOR



MULTIPLE PUMP STAGES

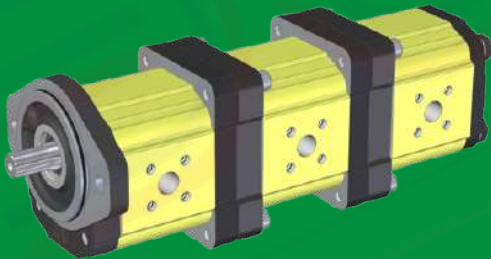

FLOW DIVIDER WITH VALVES



FLOWDIVIDER



SPECIAL FLOWDIVIDER



PMP
INDUSTRIES

OUR PRODUCTS



**PMH M/ MCF/ MK
(FIXED DISPLACEMENT MOTOR)**



**PMB
(MIXER TRUCK GEAR BOX)**



**PMH M/ MCF/ MKF
(FIXED DISPLACEMENT MOTOR)**



**PMC
(Travel Drives for Track Applications)**





Impro
Fluidtek

OUR PRODUCTS

ORBITAL MOTOR (WP)

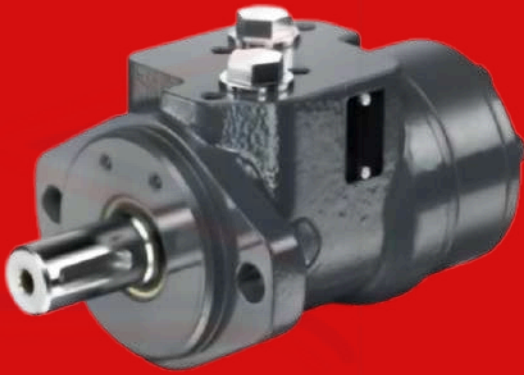

ORBITAL MOTOR (RE SERIES)



ORBITAL MOTOR (WS)

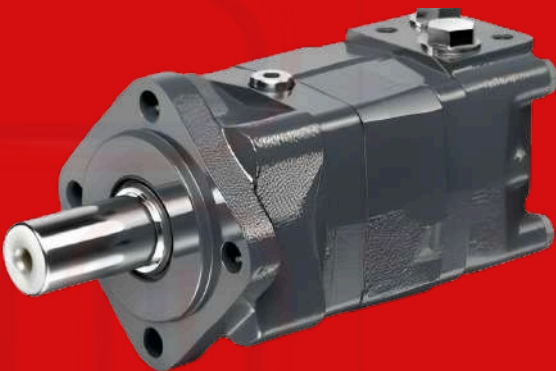

ORBITAL MOTOR (WR)



Power Pack Manufacturing

We also manufacture Power Packs as per customer requirement and can offer complete hydraulic design for any application.

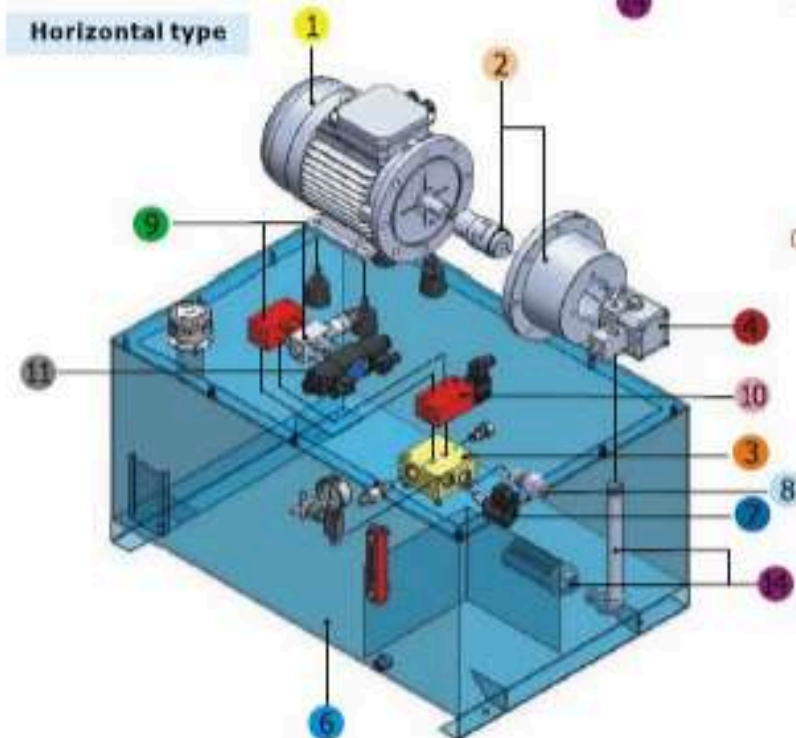
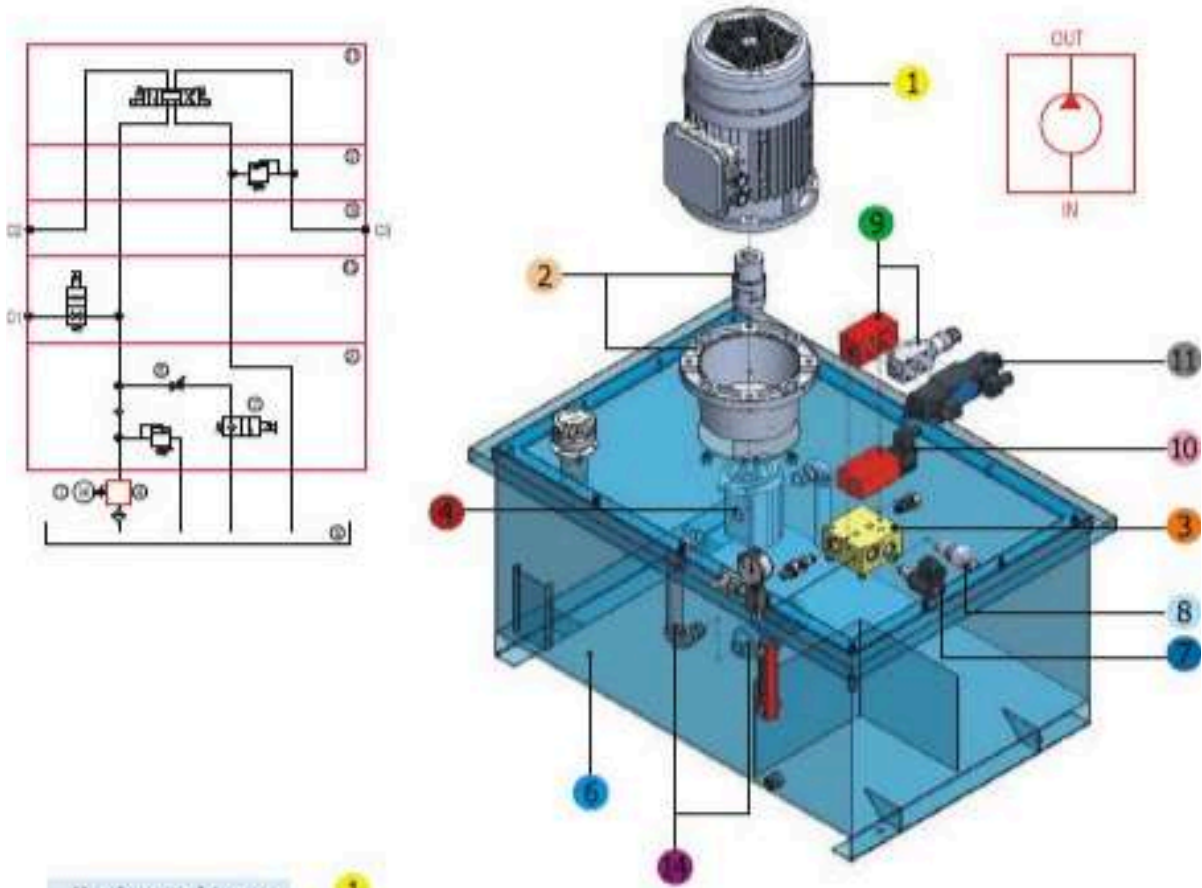

Unit Ordering Code Example

- 1 AC/ DC MOTOR
- 2 Bell Housing
- 3 Base Block: As per Circuit
- 4 Pump: Vane Pump, Gear Pump, Axial Piston Pump
- 5 Mounting: As required
- 6 Oil Tank: As required
- 7 Built In: Solenoid Valve as per Circuit
- 8 Built In: With Speed control valve if required
- 9 Directional Sandwich Block
- 10 Solenoid Sandwich Valve
- 11 Directional Valve

Advanced Testing and Expert Repair Solutions

- We provide test bench diagnostics to assess equipment performance, and if any issues are found, we offer expert repair services.
- We specialize in providing high-quality repair services for a wide range of systems and equipment, with a unique focus on test bench diagnostics to ensure your machinery are thoroughly assessed before and after repairs.
- This rigorous testing ensures that each item is thoroughly assessed, and if any issues are detected, our skilled technicians are equipped to handle the repairs promptly and efficiently.



- Our mission is to deliver fast, reliable, and cost-effective repairs while ensuring a seamless customer experience.
- By simulating real-world conditions, we can quickly identify potential issues and determine the root cause of any malfunctions. This rigorous testing ensures that each item is thoroughly assessed, and if any issues are detected our skilled technicians are equipped to handle the repairs promptly and efficiently.



- We understand how important it is to get your equipment working again quickly, which is why we pride ourselves on prompt services.
- We believe in building lasting relationships with our customers. That's why we offer transparent pricing, friendly service, and a satisfaction guarantee on all repairs.
- You can count on us to diagnose the problem and provide effective, long-lasting solutions.
- No job is too big or too small—let us take care of your repair needs today!

Rkolwalkar@suyojangroup.com

Vasai (East), Maharashtra-401210

+91 9321128470

Aditimestri@suyojangroup

Mahaluge, Pune - 410501.

+91 9820454870

APPLICATIONS



Excavator



Mixer truck



Cherry Picker



Roadroller



Bulldozer



Backhoe



Wheel loader



Skid loader

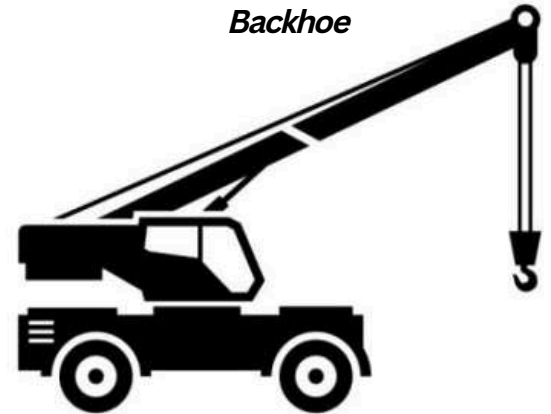

Crane



Dump Truck

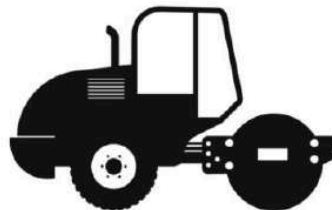

Road Roller

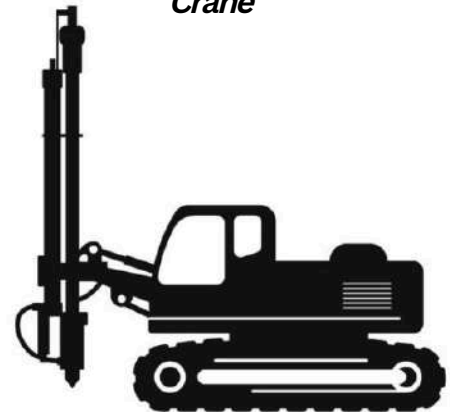

Pile Driver



Flat Bed Truck



Fork Lift

CONTACT US



+91 9321128470/ 9820454870



- 16- B, NOBLE INDUSTRIAL ESTATE, NOBLE INDUSTRIAL ESTATE NO. 1, NAVGHAR ROAD, VASAI (EAST) – 401210, DIST. – PALGHAR, MAHARASHTRA
- GATE. NO. 158, GODOWN NO. 1B, GROUND FLOOR, TALEGAON CHAKAN ROAD, MAHALUGE, PUNE - 410501.



<https://integratedhydrosystems.com/>
<https://www.danfossmotor.com/>



Suyojan.hydro@gmail.com/ Integrated.t.s@gmail.com

